

Év végi kipakolás

BAII.
Látványtervezés

MKE

TYLER SZONJA



Az ötönik huszöt

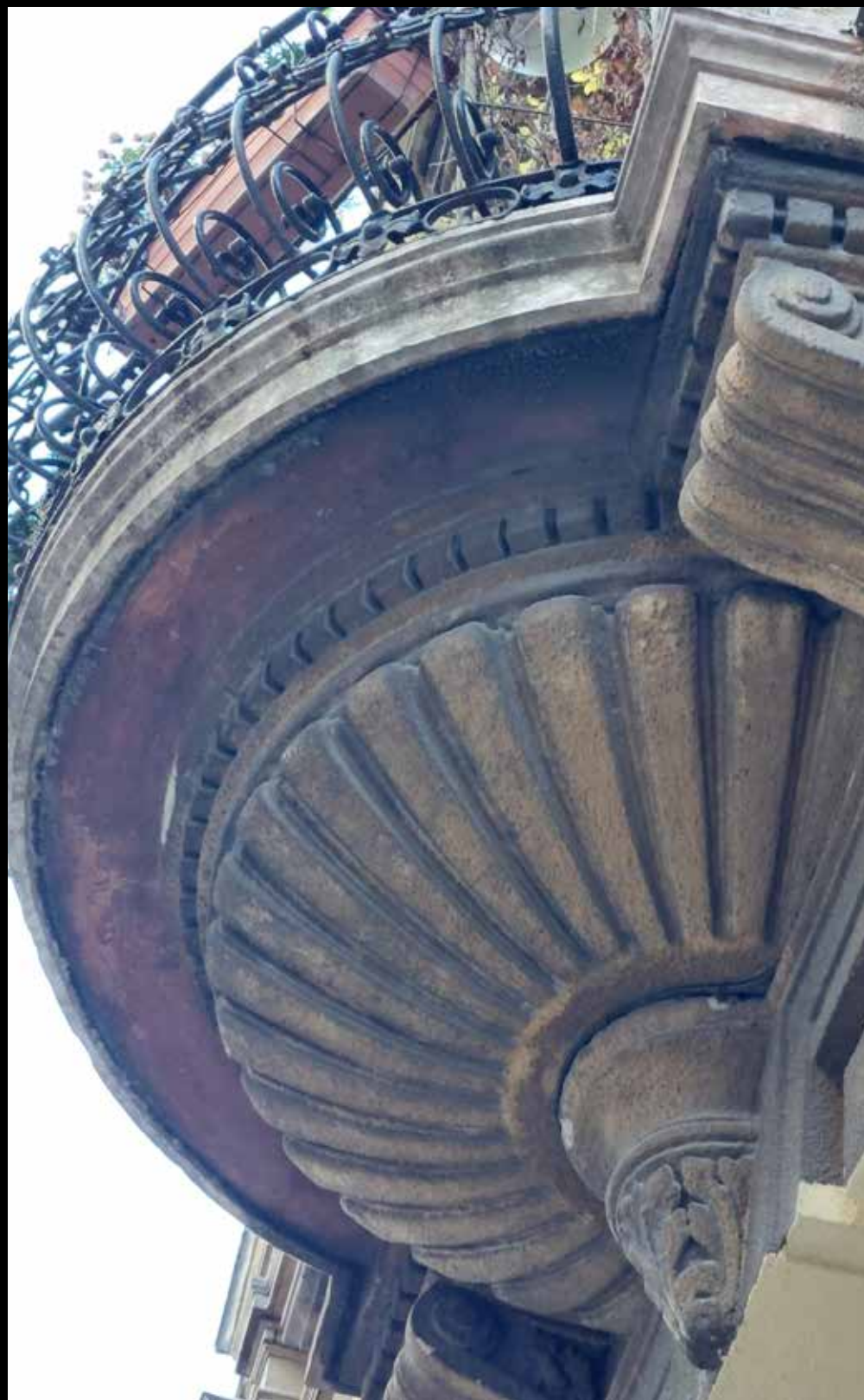

D
Í
S
Z
L
E
T



A

W
O
O
M
E
N



WCSA





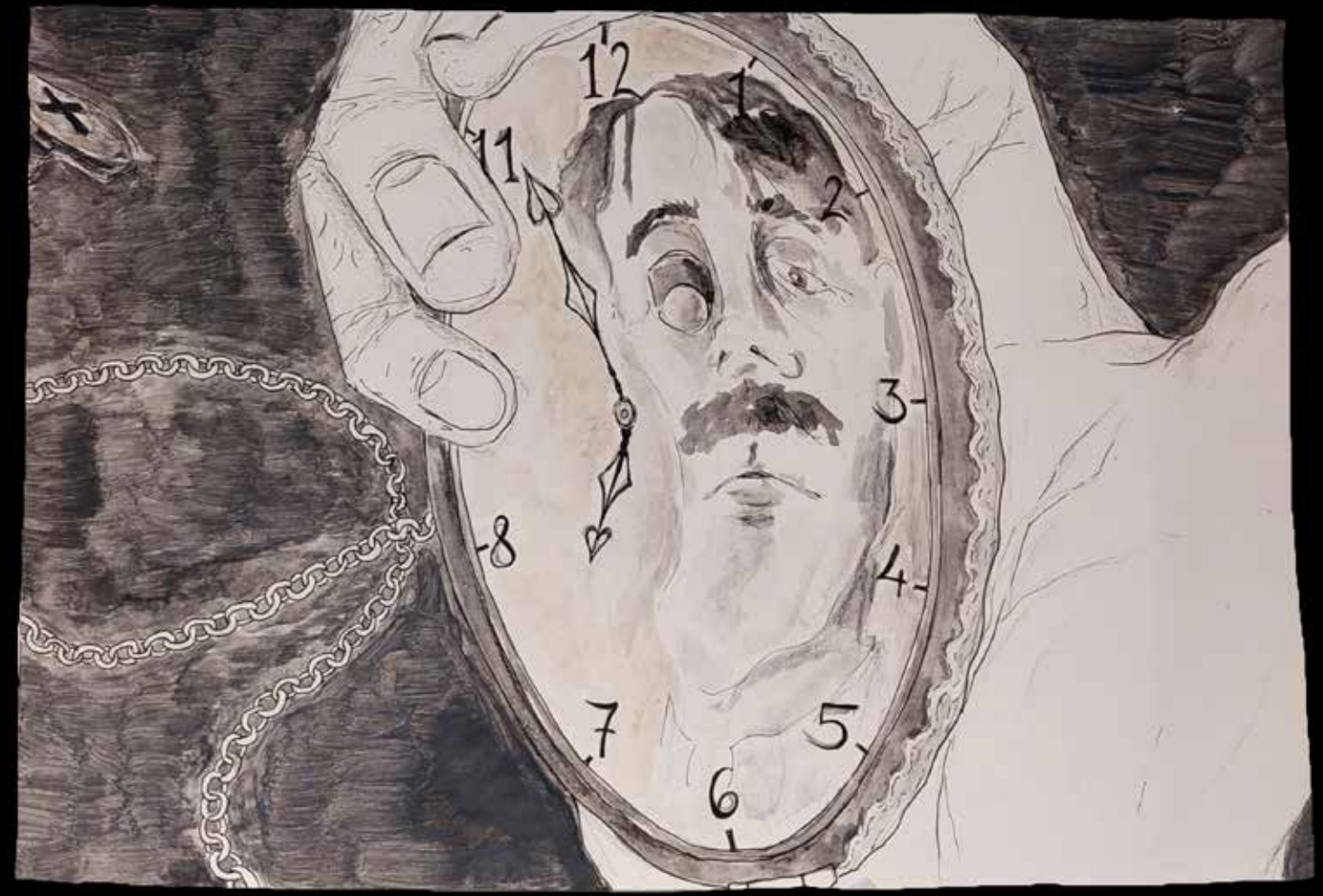

GRANIZZA

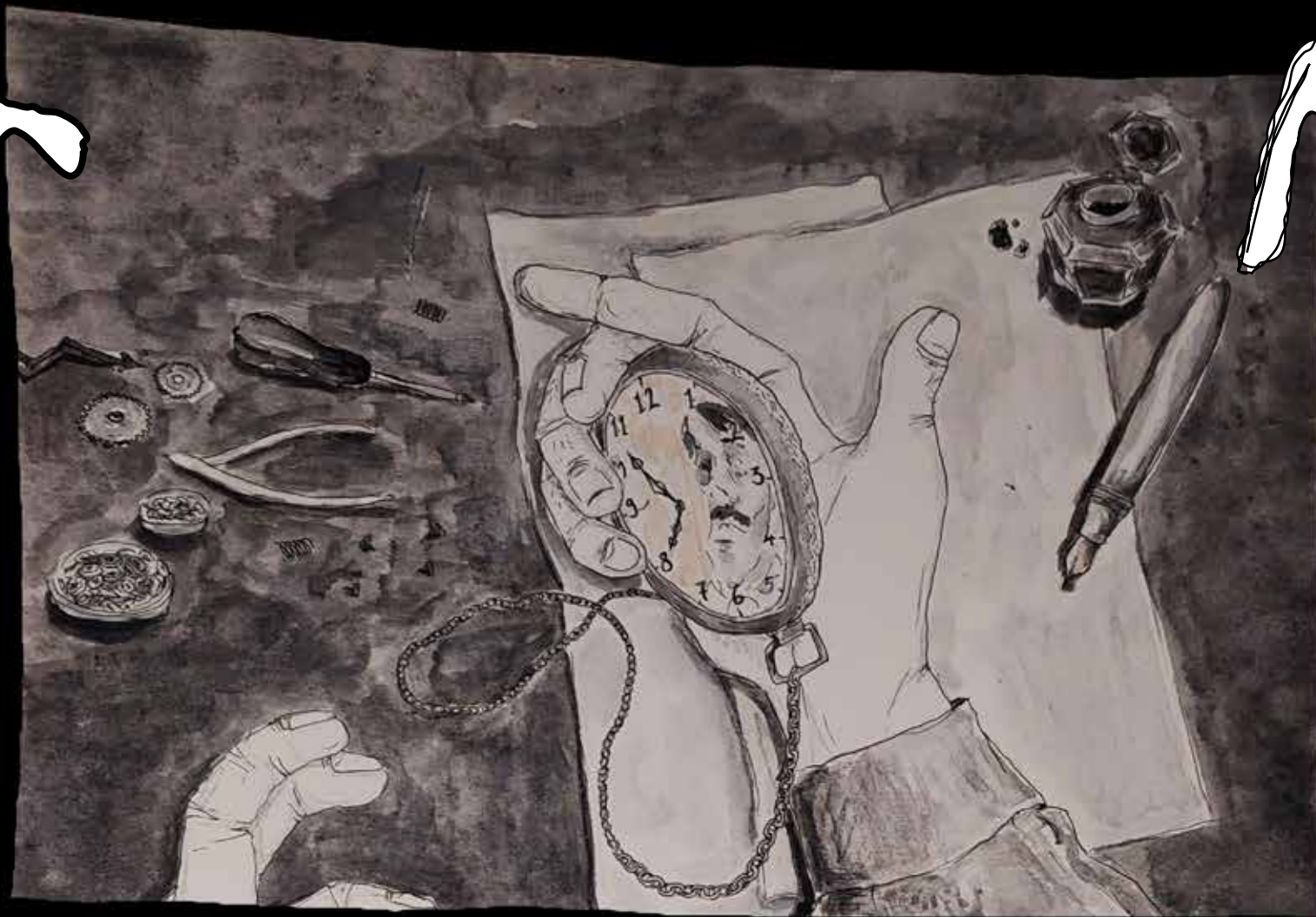

M. HELLER



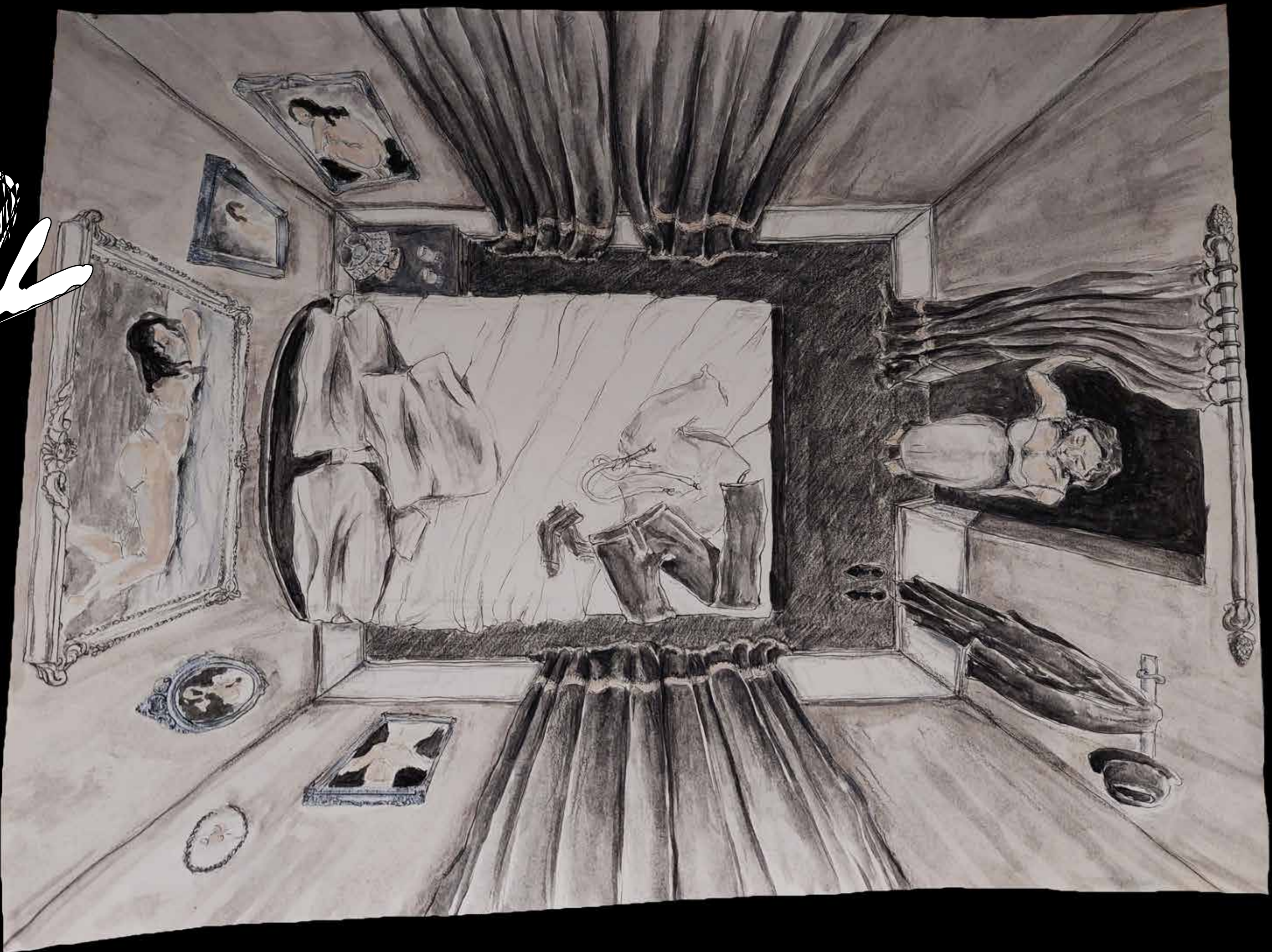

Handwritten text in a stylized, decorative font, possibly a signature or a name, located in the upper left corner of the page.

Handwritten text in a stylized, decorative font, possibly a signature or a name, located in the lower left corner of the page.

A
C
C
E
P
T
E
D
L
A
T
E
S
E



V
A
L
A
T
A



A F O G A



ア
ラ
ブ
ス
タ
ン
ド
ア
ラ
ブ
ス
タ
ン
ド





LAFORMAS



WISZKI

ZUGA







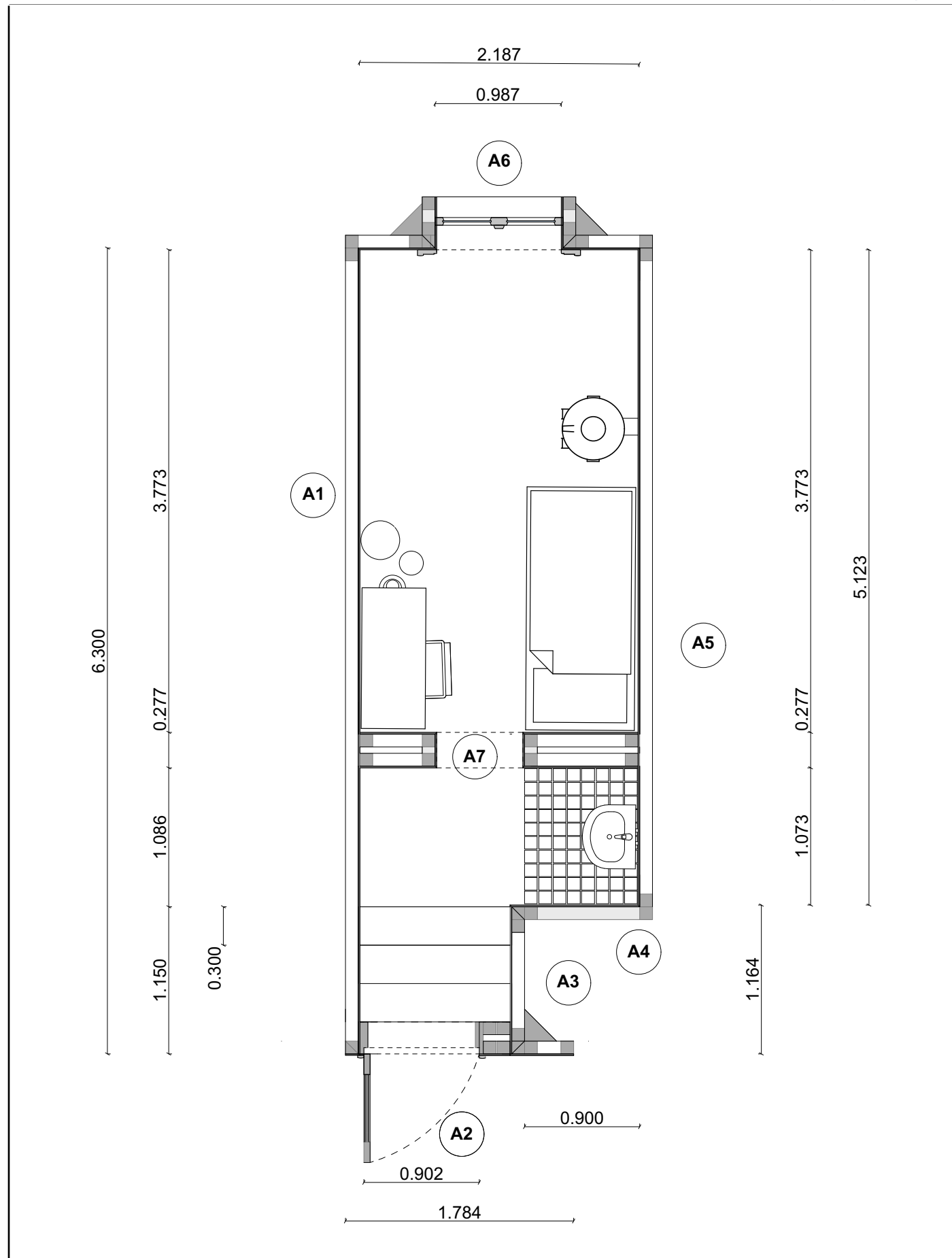

Ötödik pecsét, Keszei-zug Tyler Szonja **Alaprajz** M: 1:25

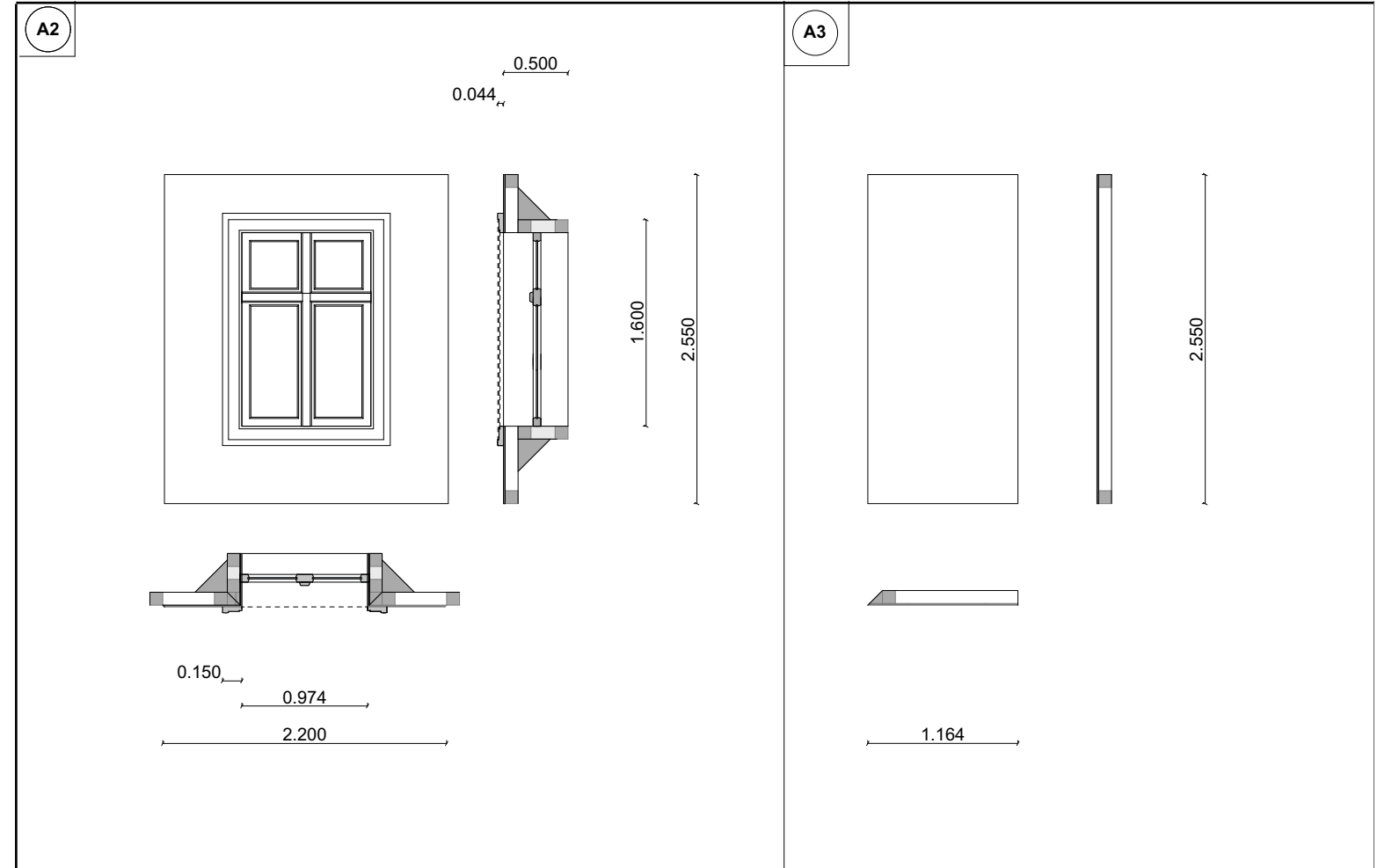

Ötödik pecsét, Keszei-zug Tyler Szonja **Falnézetek** M: 1:25

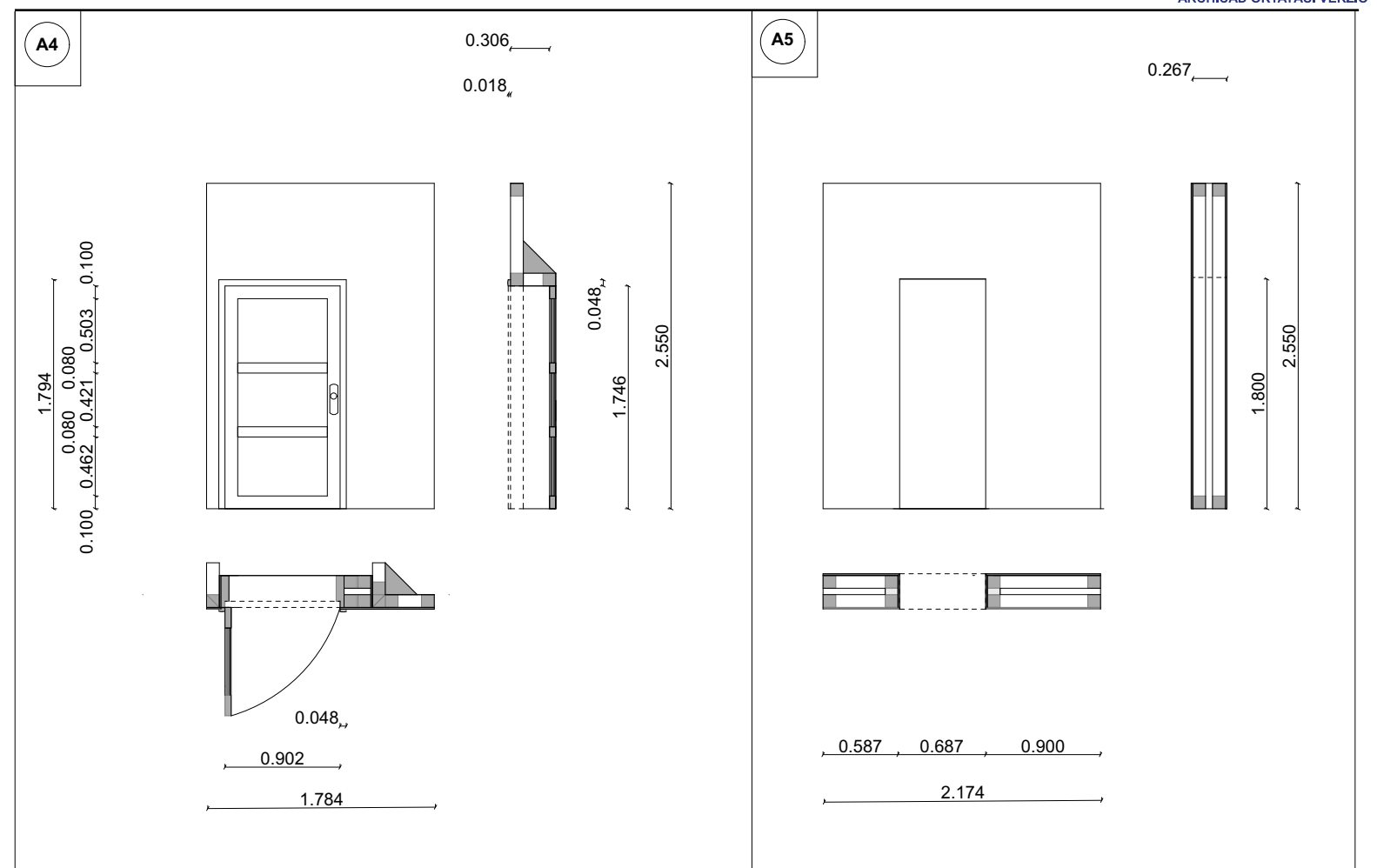

Ötödik pecsét, Keszei-zug Tyler Szonja **Falnézetek** M: 1:25

A1

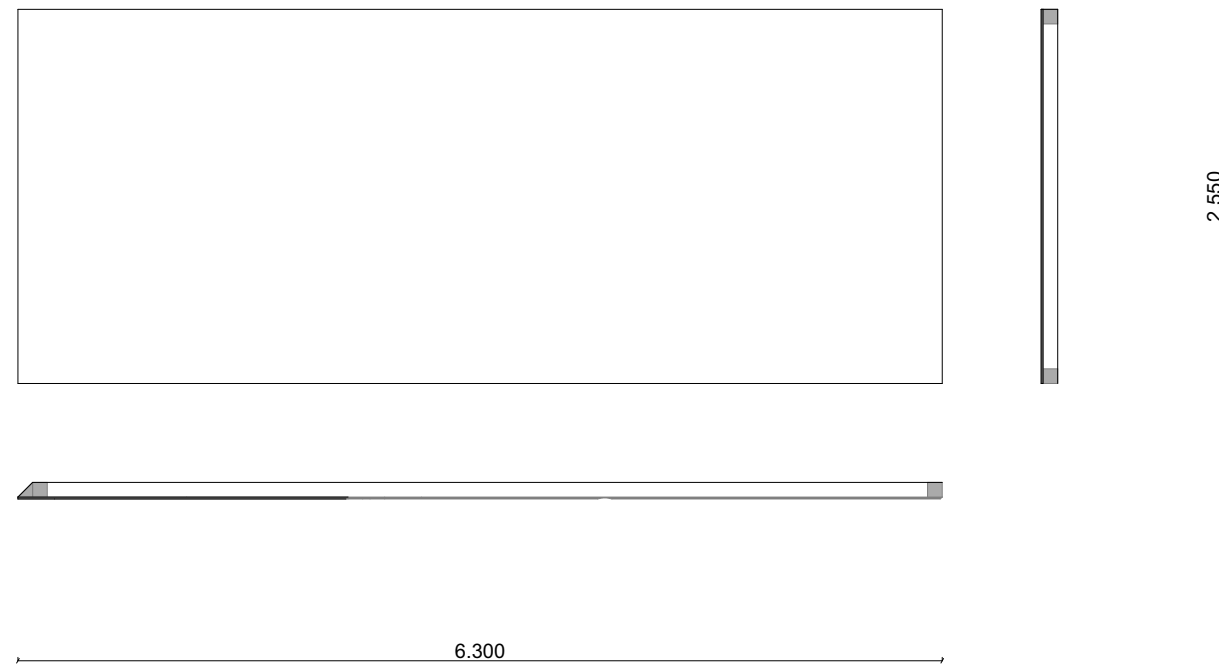

Ötödik pecsét, Keszei-zug

Tyler Szonja

Falnézetek

M: 1:25

A6

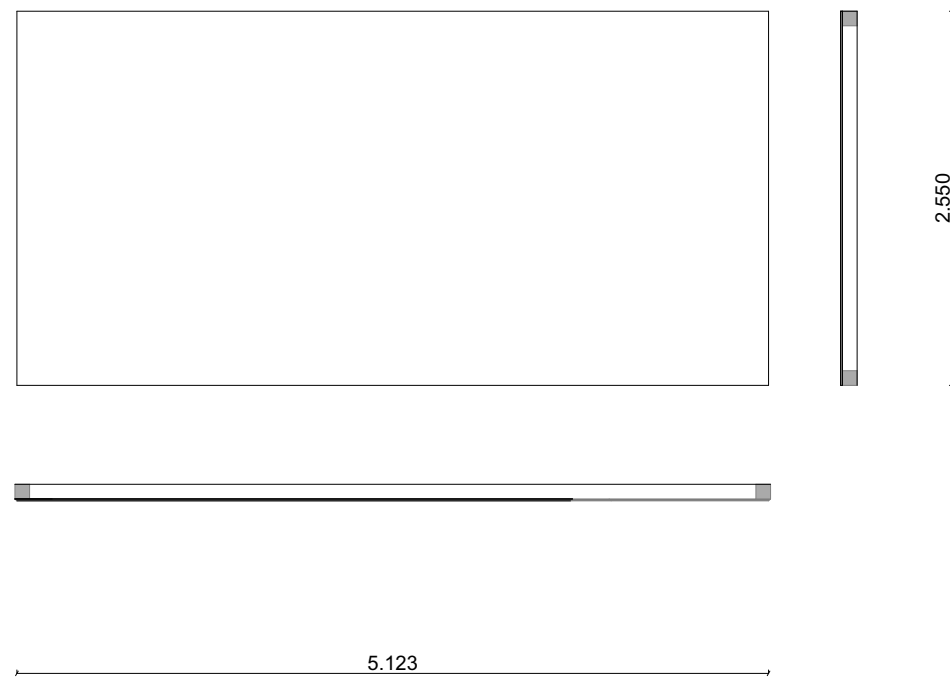

A7

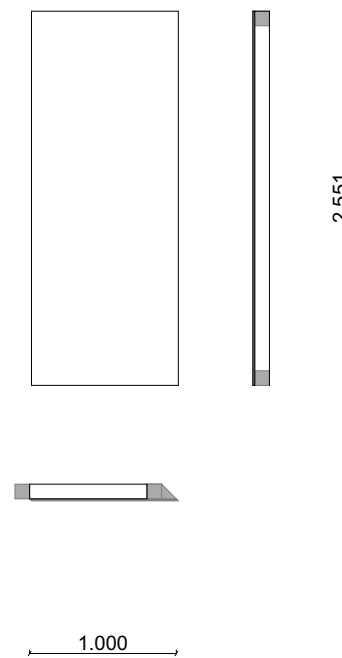

Ötödik pecsét, Keszei-zug

Tyler Szonja

Falnézetek

M: 1:25

Háy János

APALÁNYA

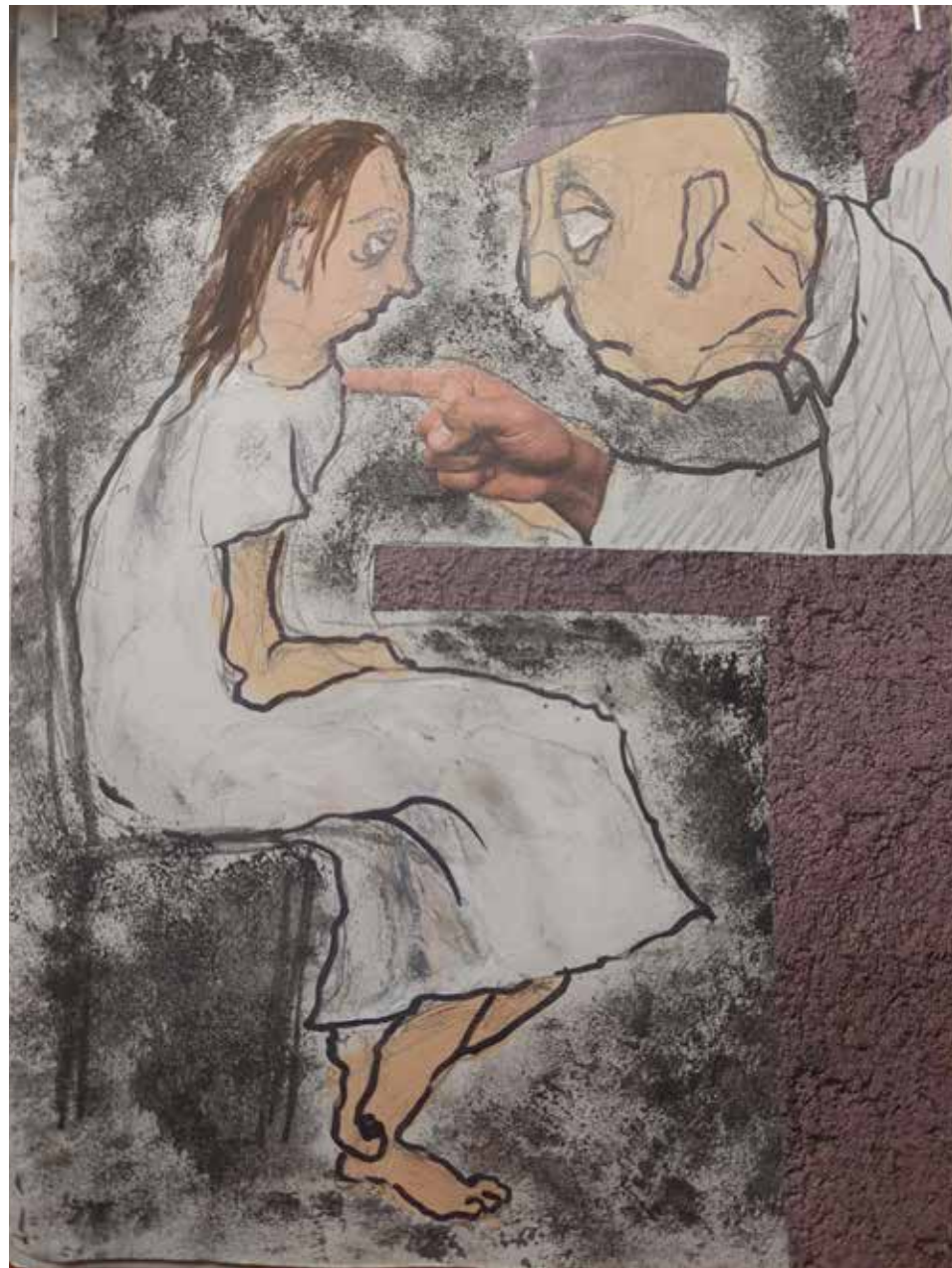

B
Á
B

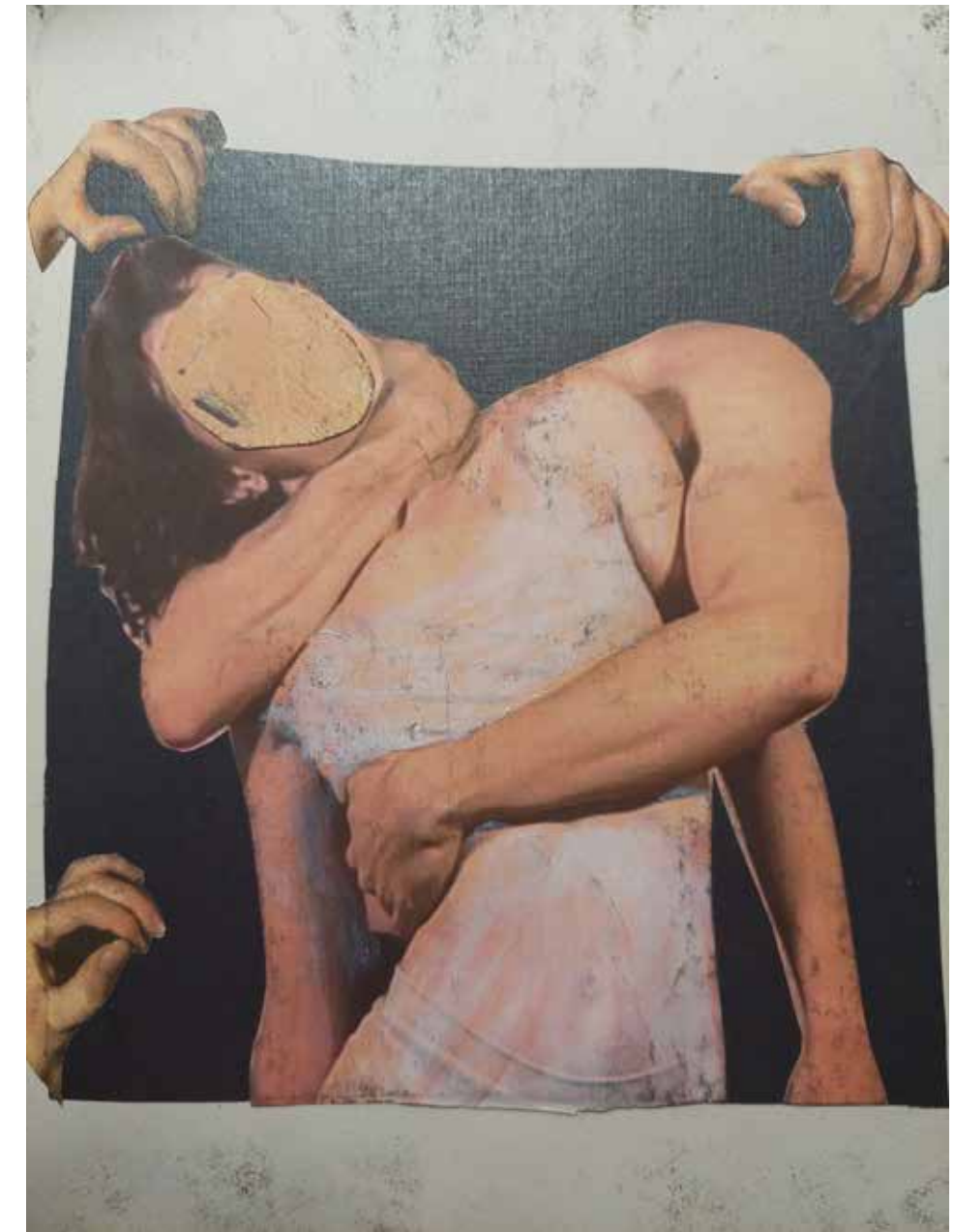
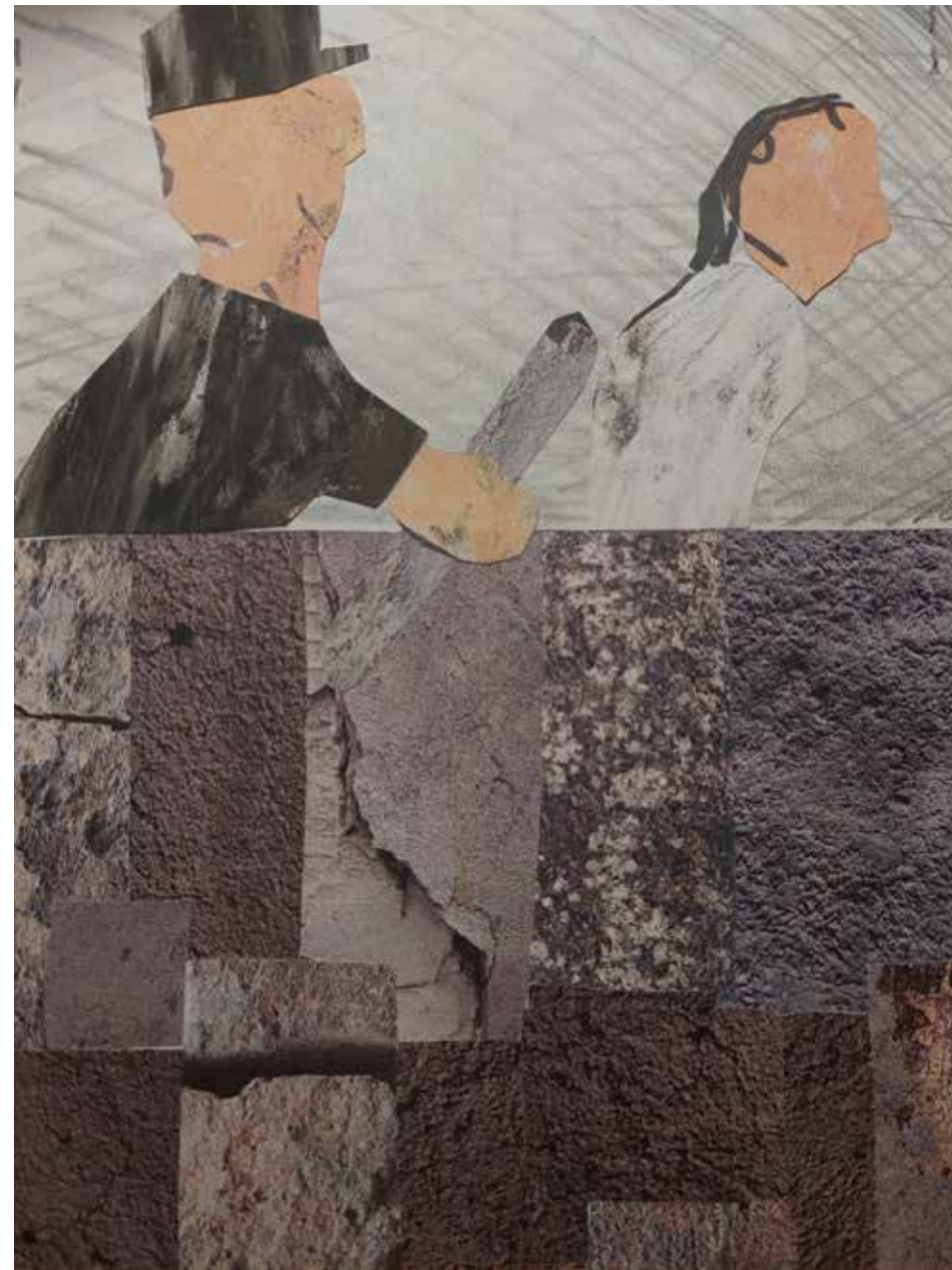

VÉGREHAJTÓ

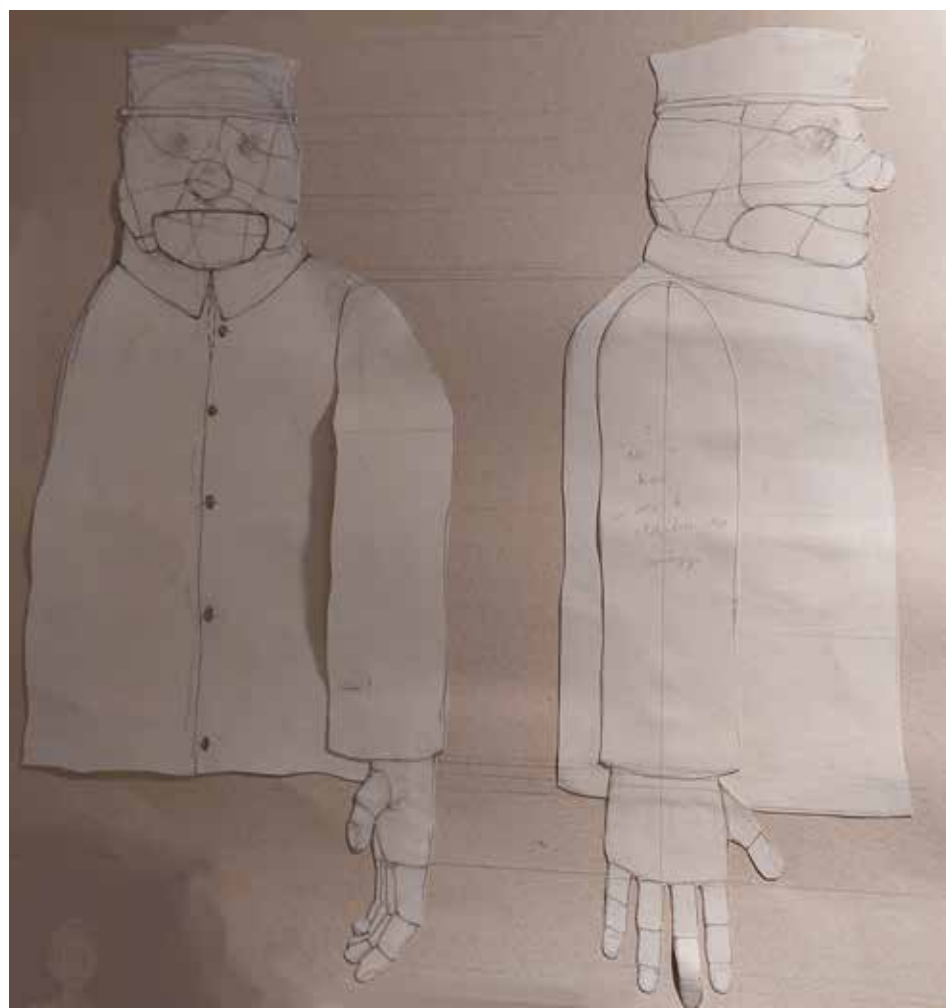

HATALOM

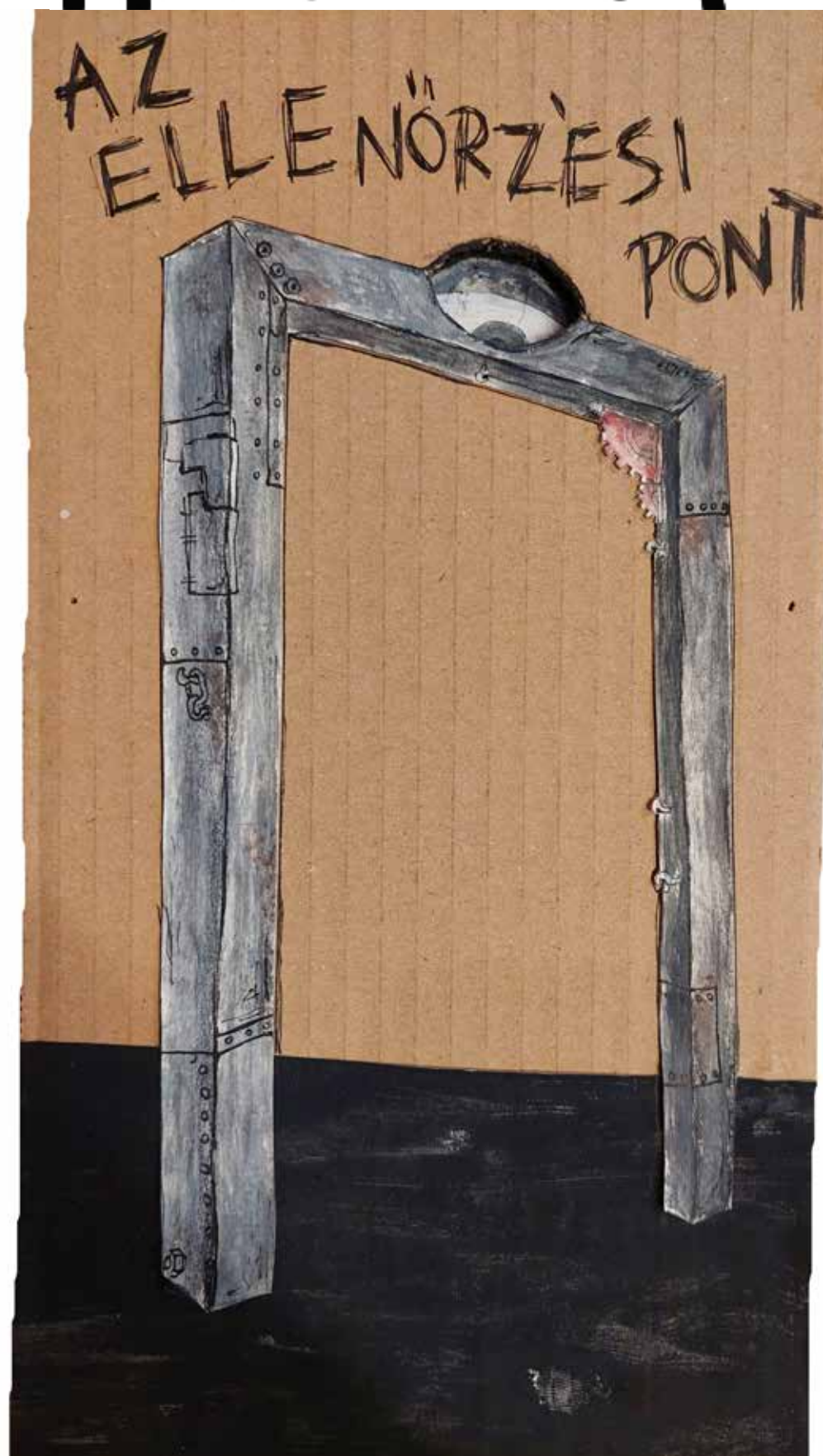

SZÜLÖK és

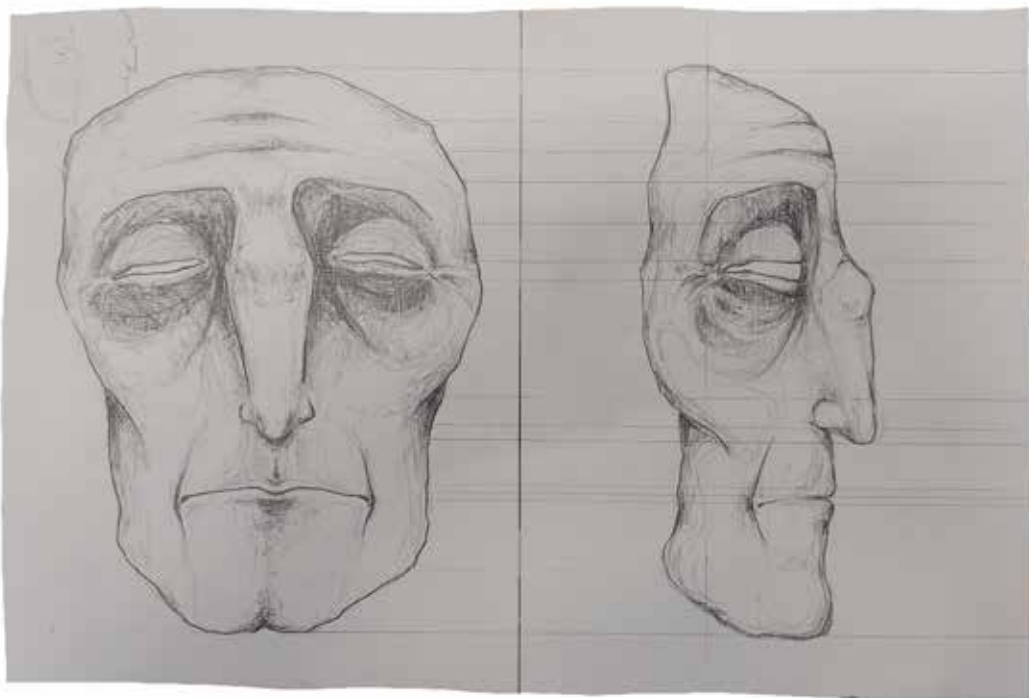
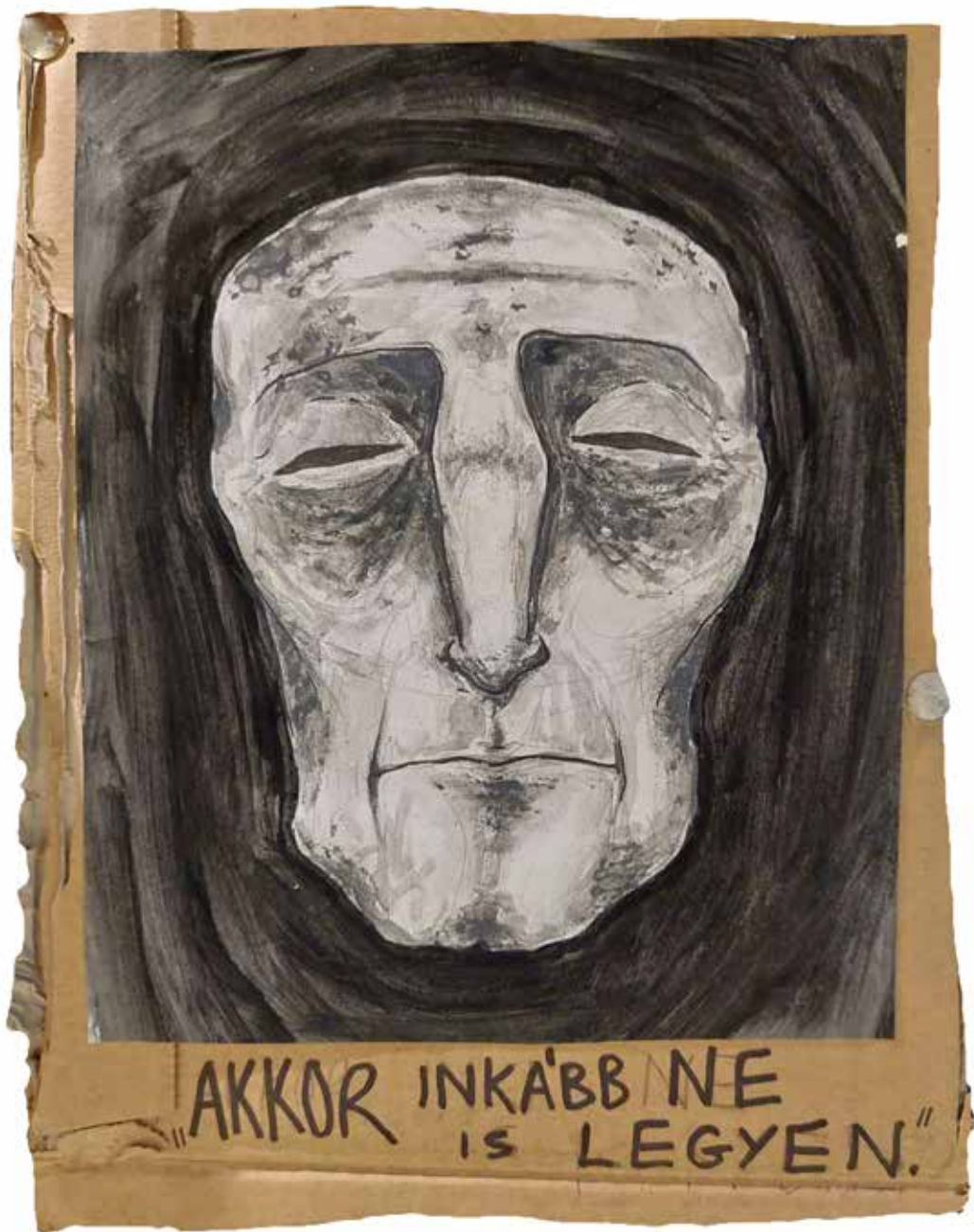



"A CSONTOKBÓL FOLYT
KI A NEDVESSEG"



"NEM, MAMA,
MEGMENTI."

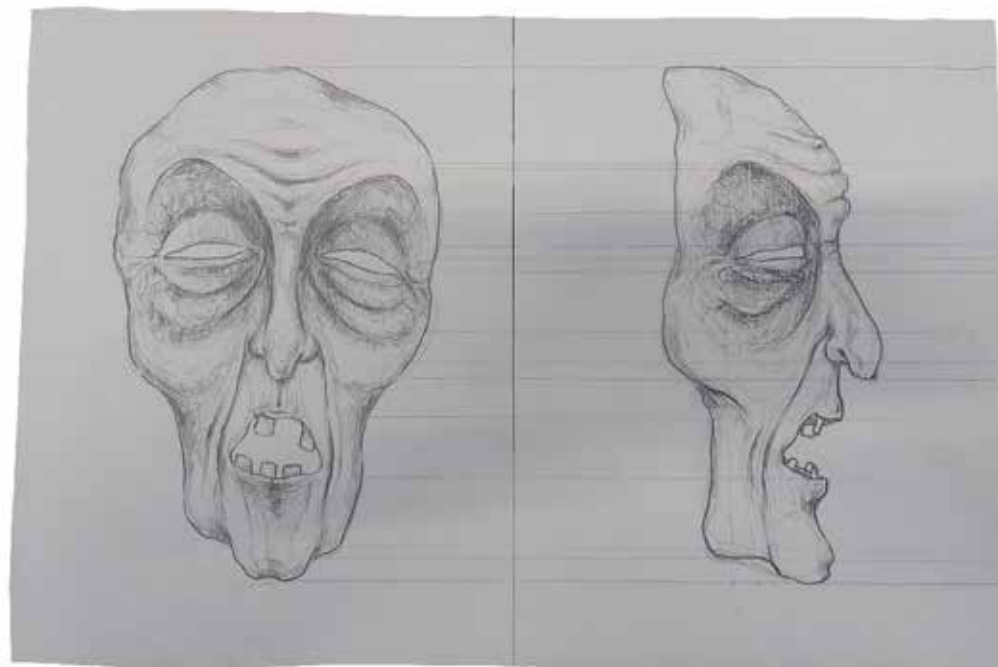

"HOGY MUTOGASSA
A JÖLLAKOTT TESTÉT" / "MEGÖLI
HALLOD?"

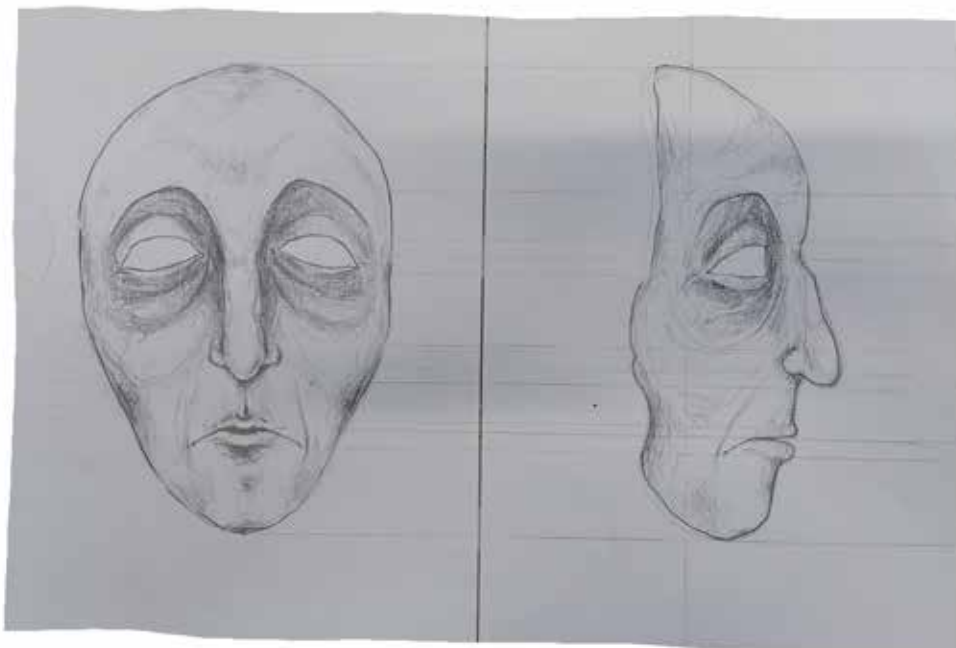
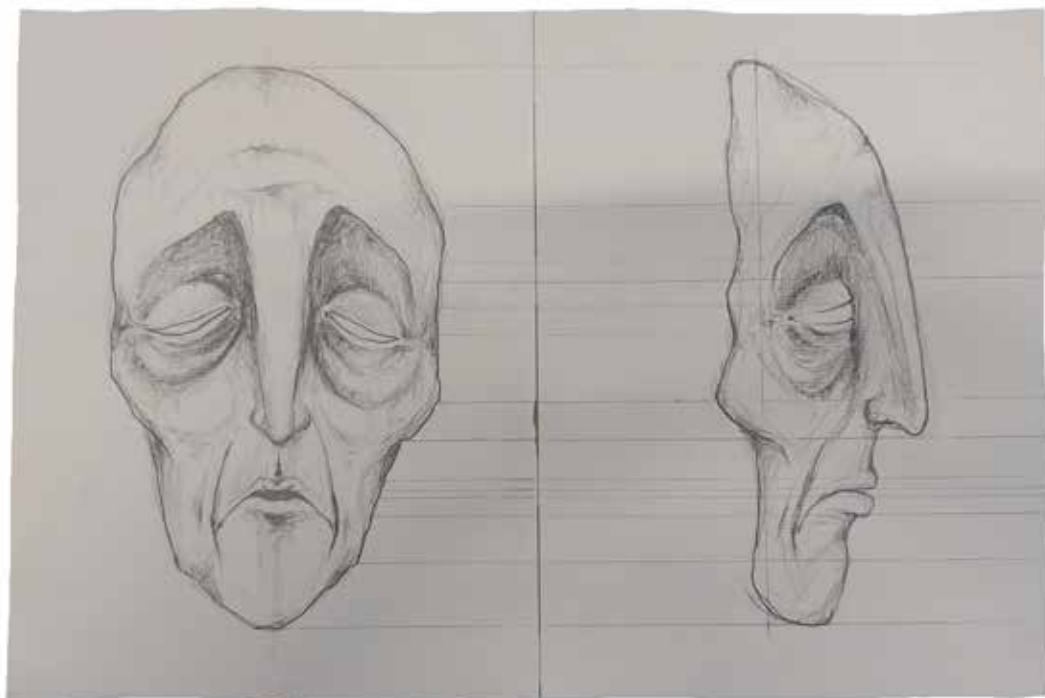

ANYA
'ES
FIA

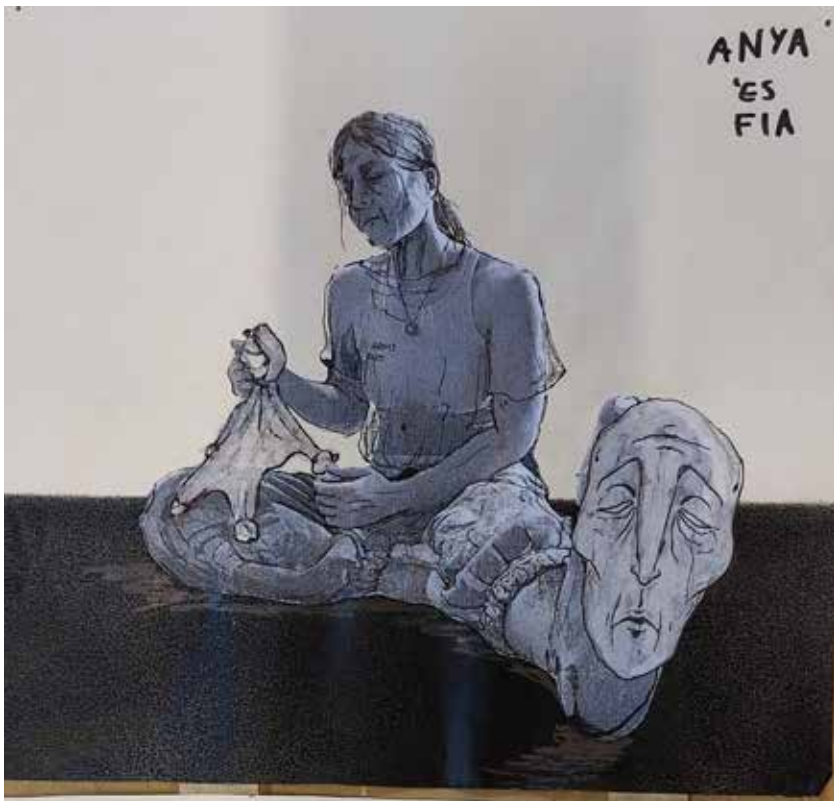

Földvári
Eszter



APA
LÁNYA
Földvári Eszter
(Apa egy keskeny fenyő alól)

6b
Kötény
Röngyökben

PELLE ZSEB
HÁTRAG ZSEB

ZSEBÉK

RENDISZERE

A GYEREKEKOT A KÖTÉNY ALÁ DUNA ZSEBÉRE TESZI

TÉRISZLEK

SOVOLT

RENDISZERE

A. SZINESZNŐ



MACSEJ

AZ ÚJVILÁG UTCÁN...



MIKOR MAGANHOZ TÉRTEM...



ÁRNYJÁTÉK
AMÚGY...
(szablon - fényformák
előtt)

AZ ÍGYEAN ARRA A FÉRFIRA GONDOLTAM



Árnyjáték

KIVITELÉS

Kesztyűs Báb

+ ez

